

EC centrifugal fan

backward curved, single inlet

ASIA PACIFIC SHENGRUI LIMITED

Phone +00852 56261528

info@apacfan.com

www.apacfan.com

Nominal data

Type	R1G175-AB41-64	
Motor	M1G055-BD	
Nominal voltage	[VDC]	48
Nominal voltage range	[VDC]	36-57
Type of data definition		rfa
Speed	[min ⁻¹]	3100
Power input	[W]	34
Current draw	[A]	0.85
Min. ambient temperature	[°C]	- 25
Max. ambient temperature	[°C]	+70
Air flow	[m ³ /h]	565
Sound pressure level	[dB(A)]	64,4

ml = max. load · me = max. efficiency · rfa = running at free air · cs = customer specs · cu = customer unit
Subject to alterations

Technical features

Leakage current	<=0.25 mA
Size	175 mm
Operation mode	Continuous operation(S1)
Direction of rotation	Clockwise, seen on rotor
Mounting position	Any direction
EMC interference emission	Acc. to EN 61000-6-3
EMC interference immunity	Acc. to EN 61000-6-2
Insulation class	"B"
Cable exit	Variable
Condensate discharge holes	None
Bearing motor	Ball bearing
Mass	0.85kg
Material of impeller	PA66
Motor protection	Reverse polarity and locked-rotor protection
Product conforming to standard	EN 60950-1
Surface of rotor	Coated in black
Number of blades	7
Type of protection	IP 44
Technical features	Control input PWM - Tach output - Motor current limit - Soft start
Max. permissible ambient motor temp. (transp./ storage)	+70 °C
Min. permissible ambient motor temp. (transp./storage)	-40 °C
Approval	VDE, CE, UL507, CCC
Rotor weight	423g
L10 at 40 °C	60000h
Start voltage	36V
Max running current	0.9A
Locked rotor current	0.5A
Protection for rotor blocked	OK
Protection for over current	OK
Soft starting	OK
Restart automatically	OK
Protection for positive and Negative polarity connection	OK

EC centrifugal fan

backward curved, single inlet

Product drawing

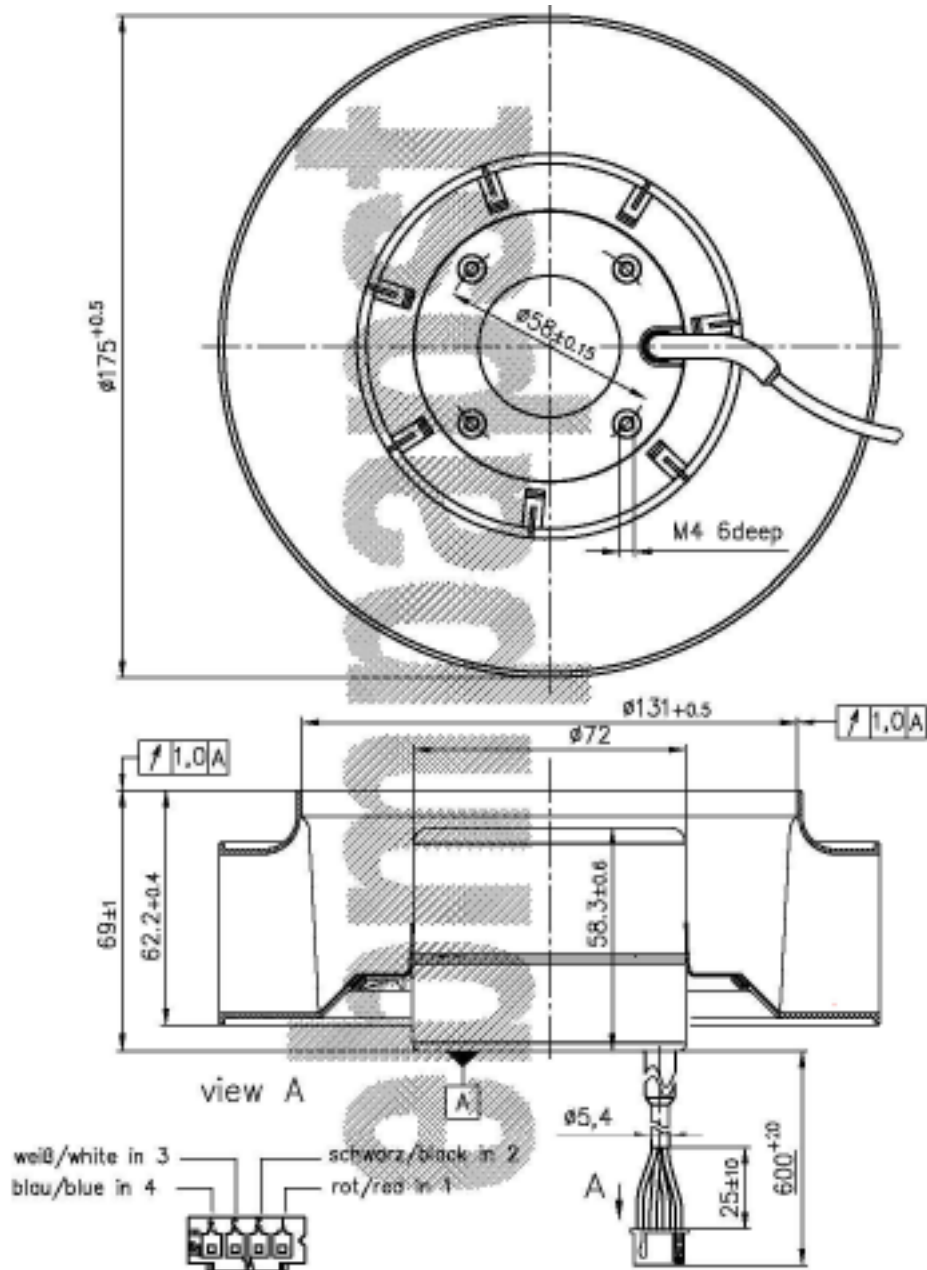

- | | |
|---|---|
| 1 | Connection line AWG20/300V, 4-leads |
| 2 | Housing JST: XHP-4 |
| 3 | Pin JST: SXH-001T-P0.6 |
| 4 | Amounting hole M4, 6mm depth, torque 1.57Nm |

EC centrifugal fan

backward curved, single inlet

PWM VS Speed

PWM VS Speed

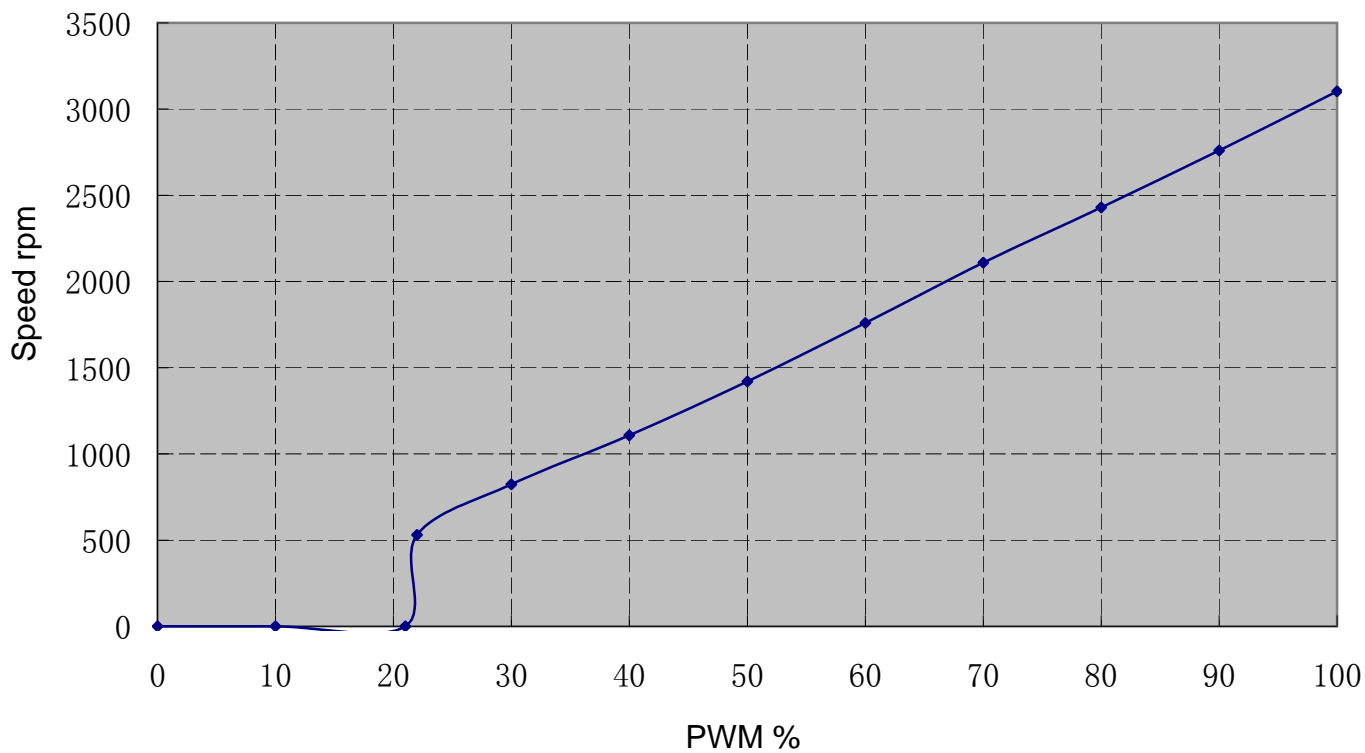

EC centrifugal fan

backward curved, single inlet

100% PWM PQ curve under 36V

All tested with wall ring 09576-2-4013

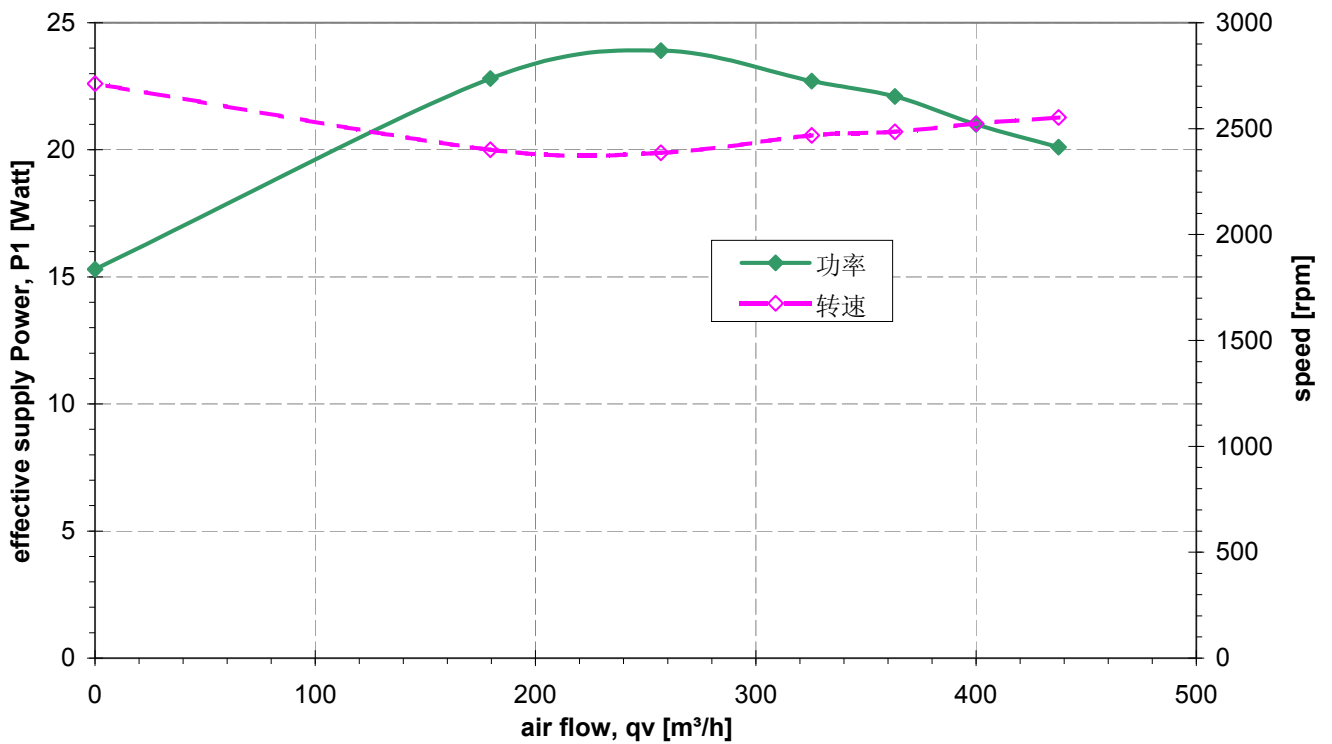
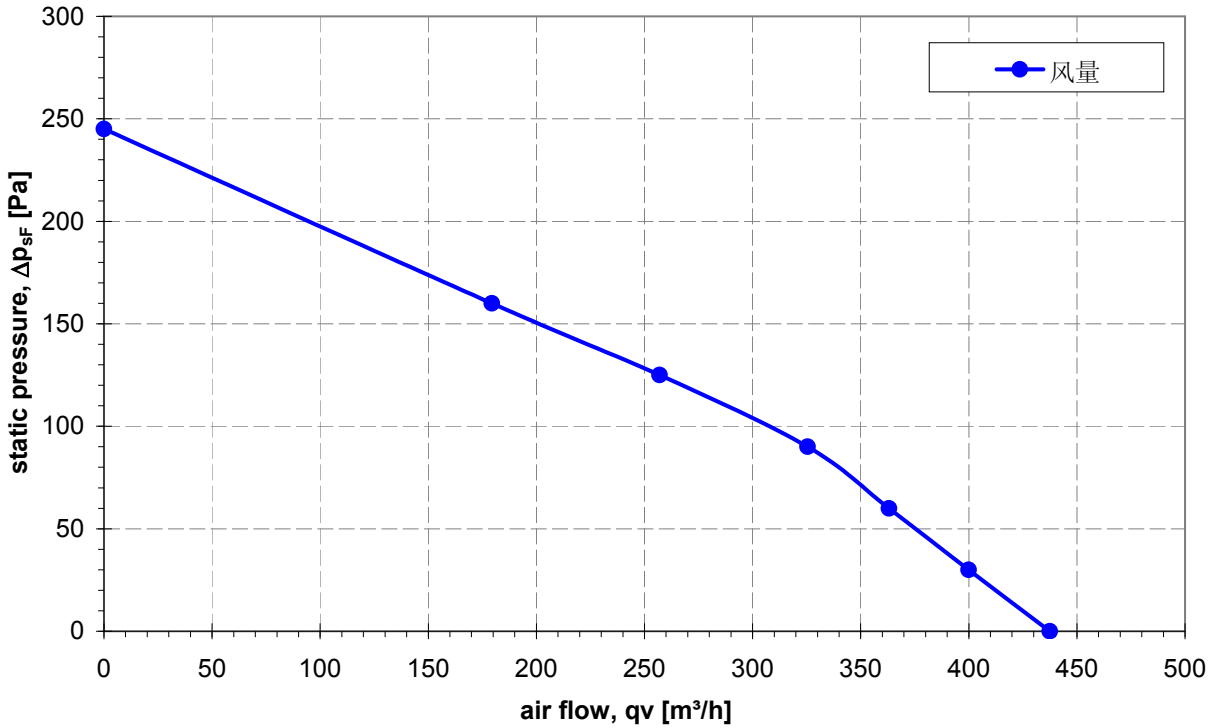

EC centrifugal fan

backward curved, single inlet

100% PWM PQ curve under 56V

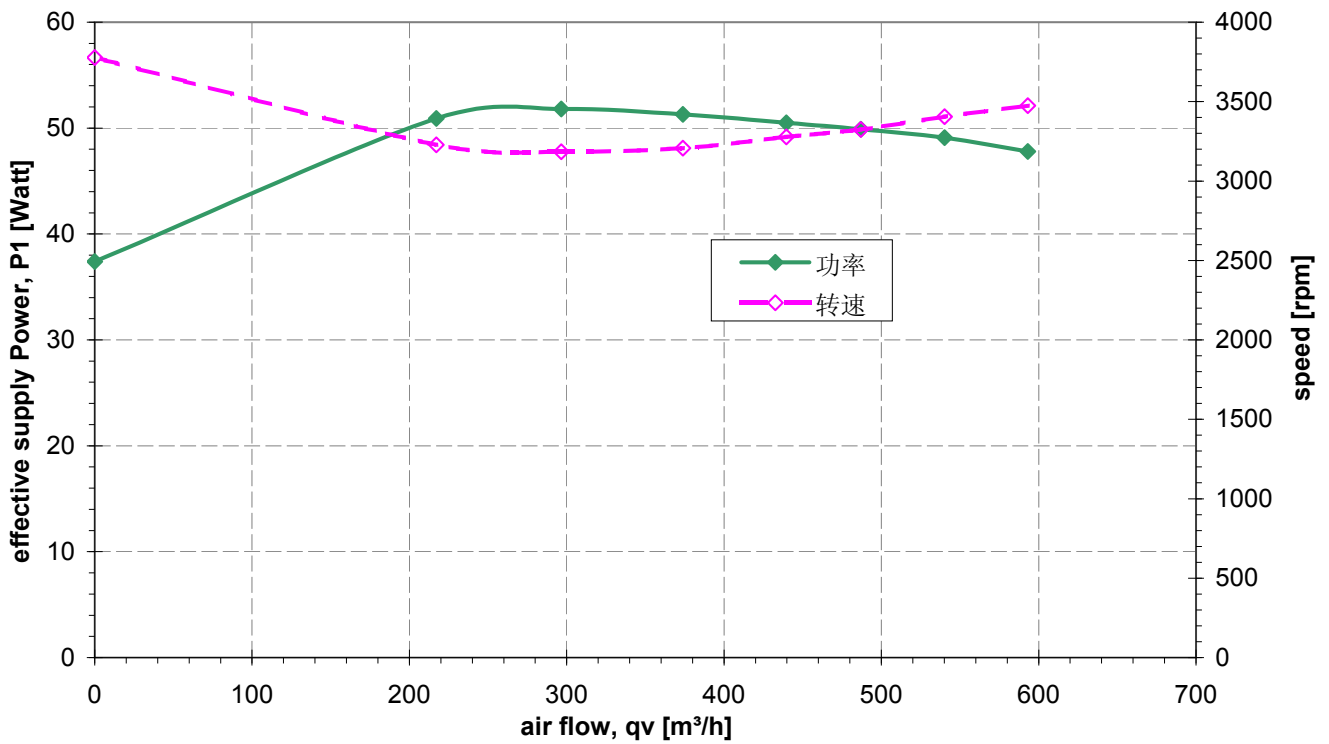
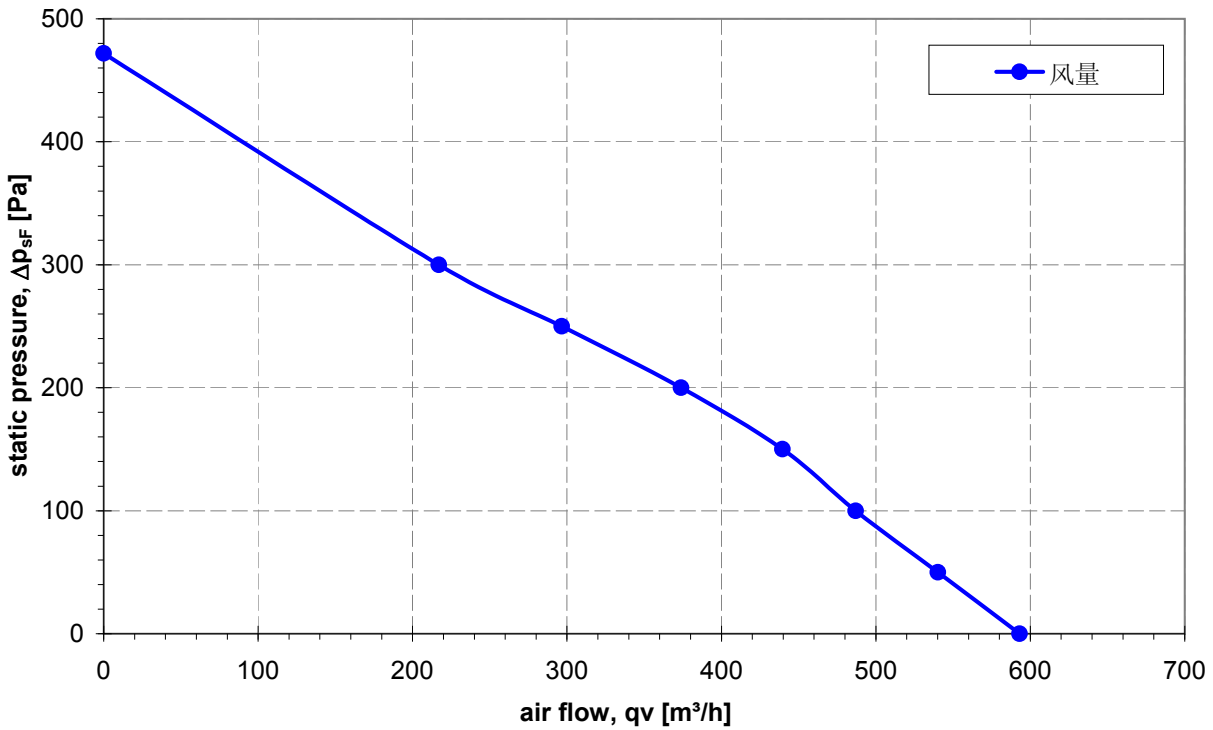

EC centrifugal fan

backward curved, single inlet

22% PWM PQ curve under 48V

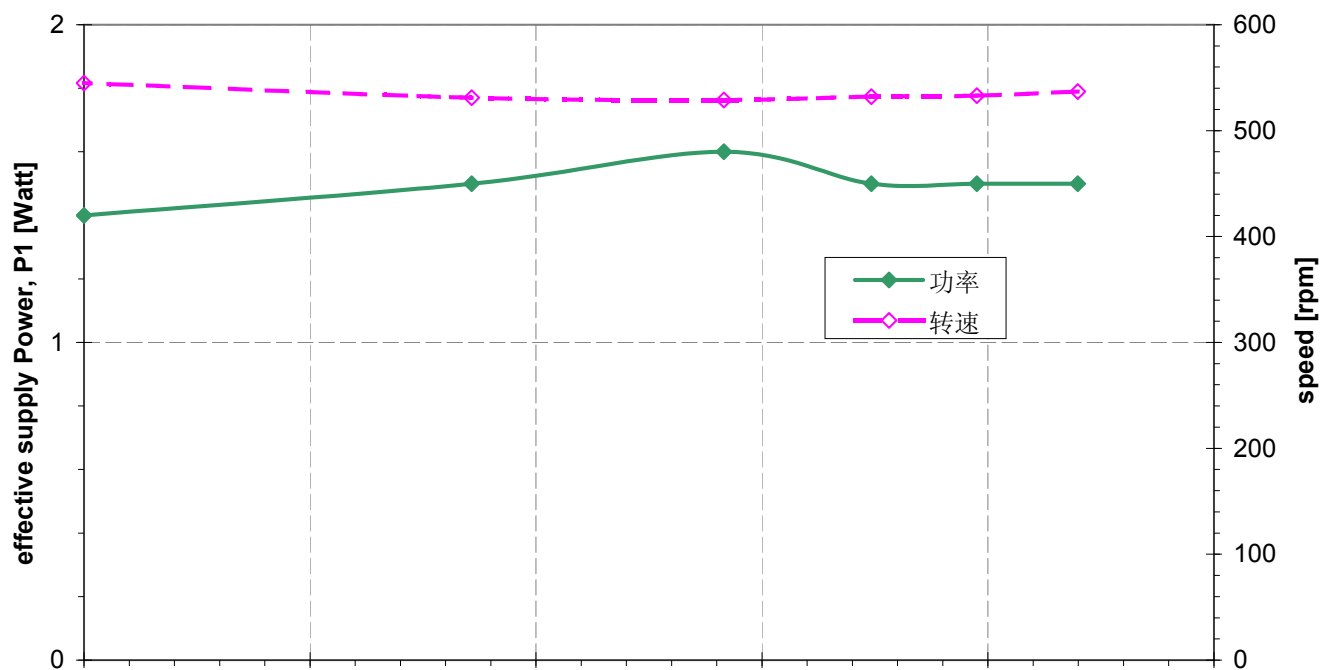
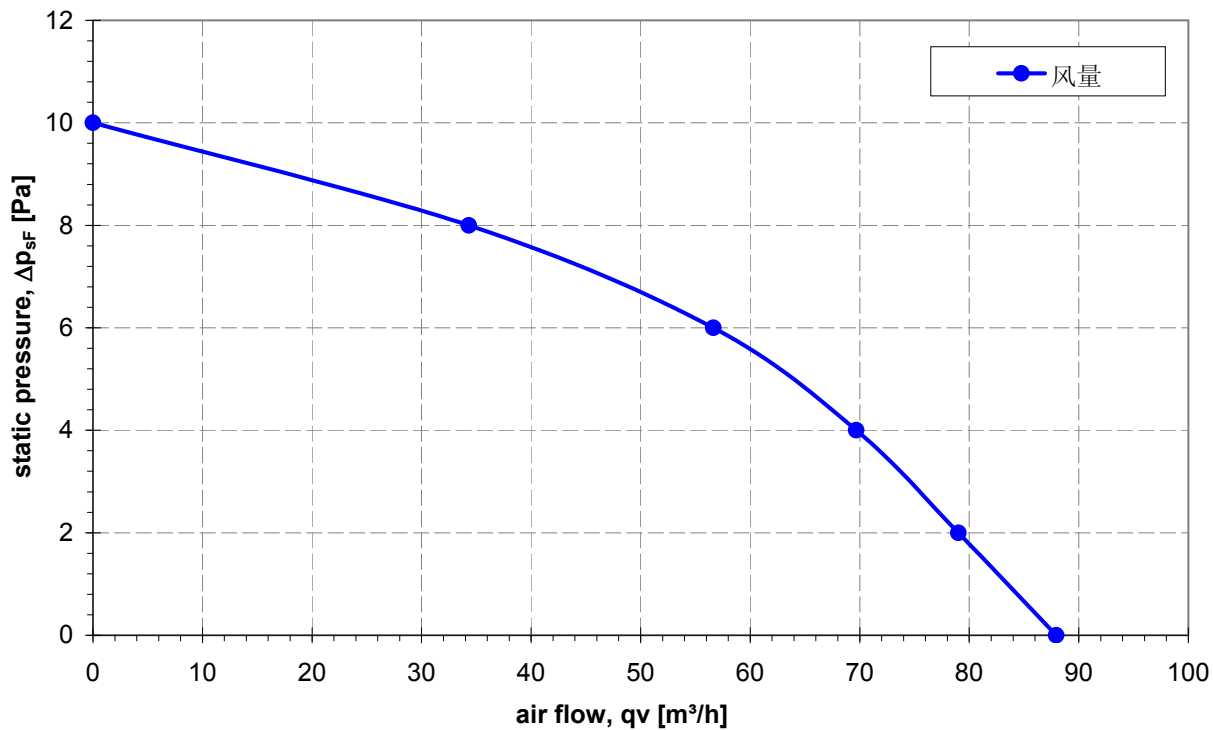

EC centrifugal fan

backward curved, single inlet

30% PWM PQ curve under 48V

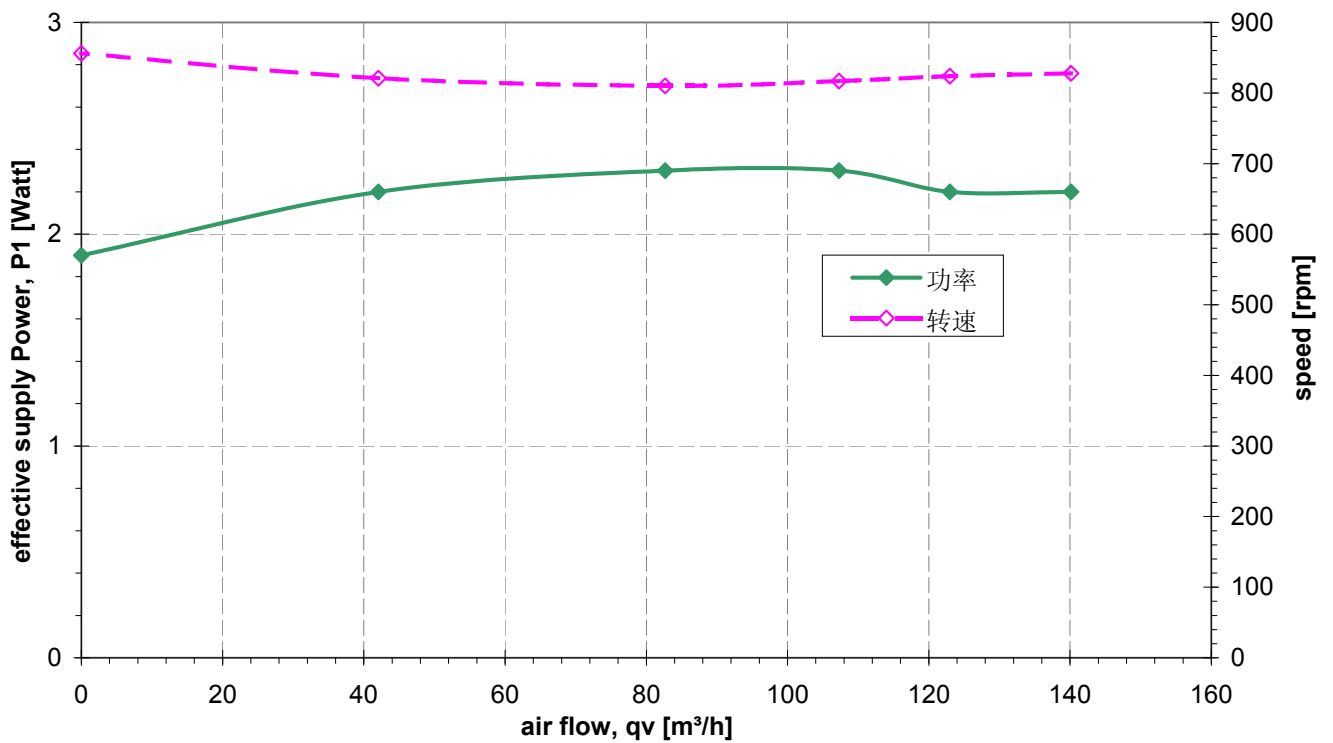
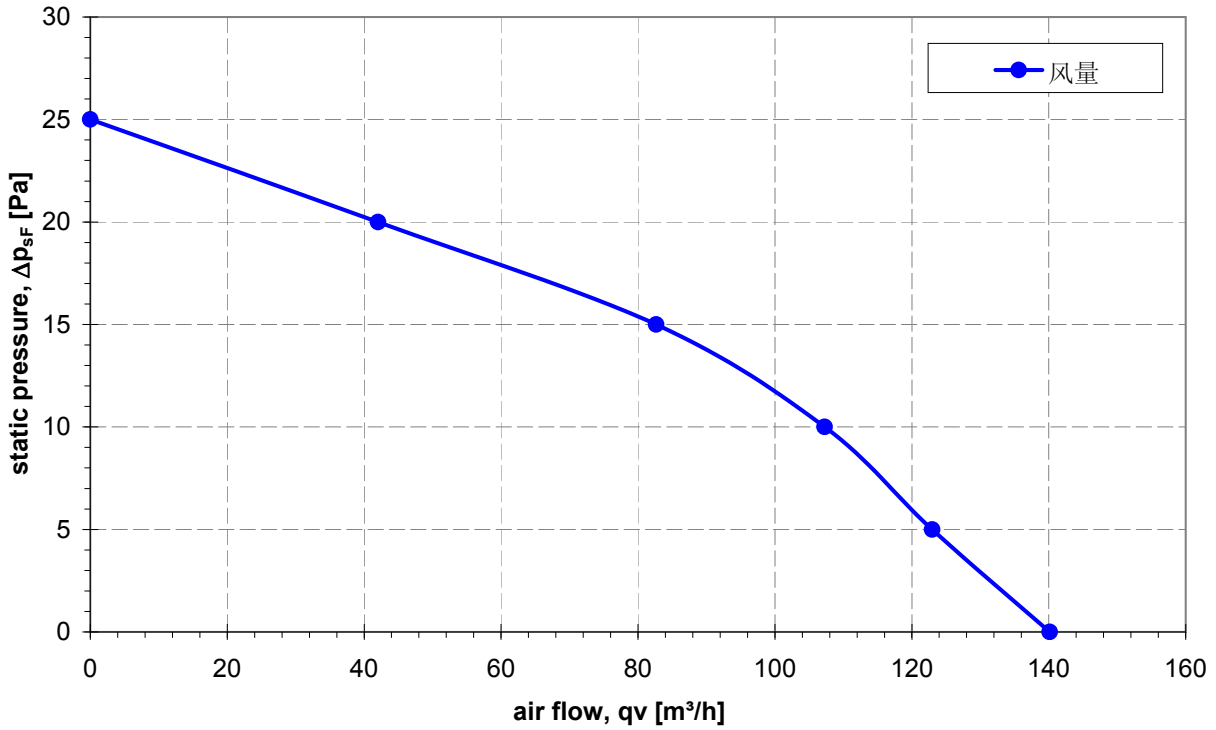

EC centrifugal fan

backward curved, single inlet

40% PWM PQ curve under 48V

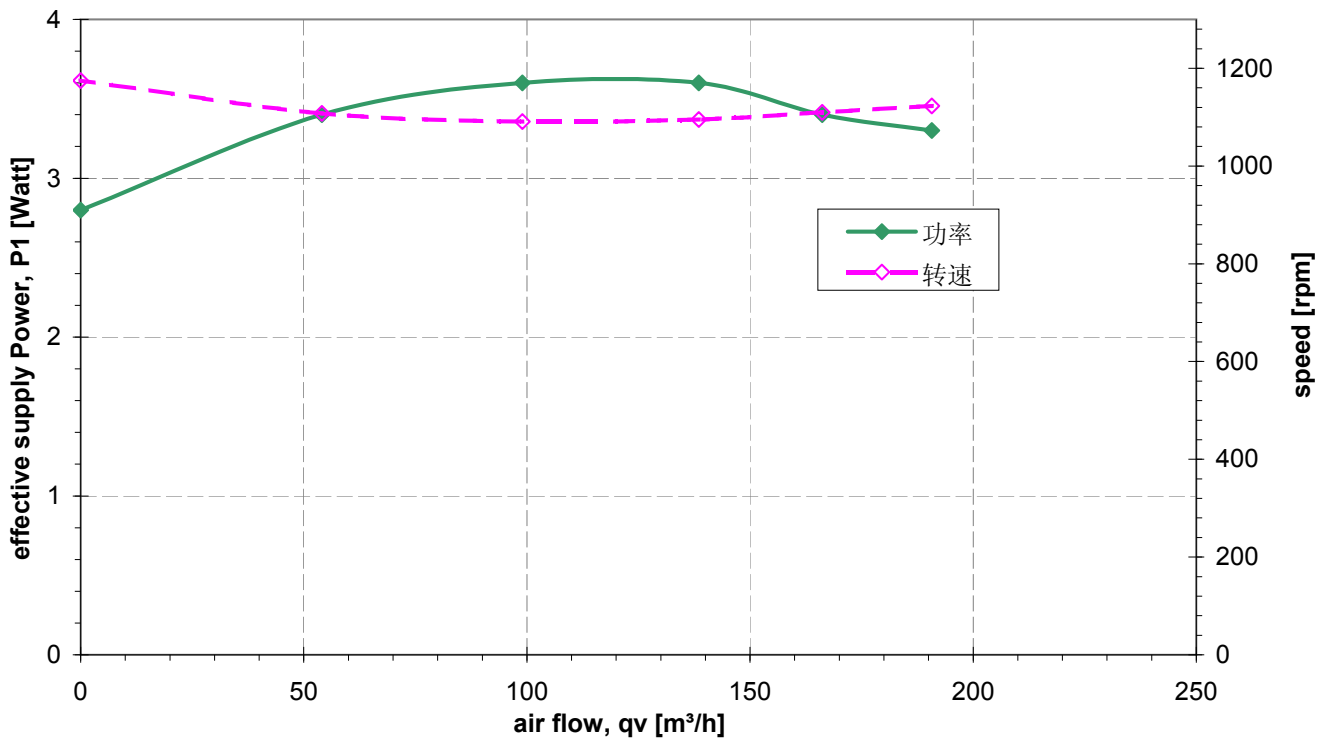
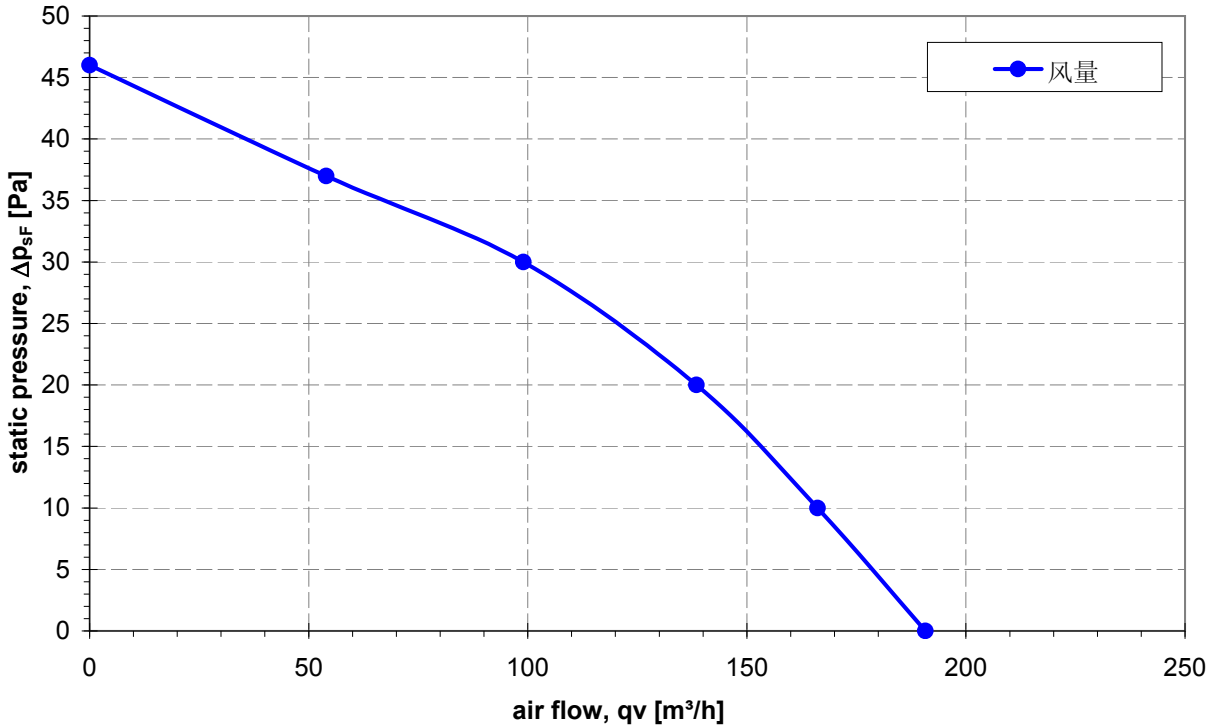

EC centrifugal fan

backward curved, single inlet

50% PWM PQ curve under 48V

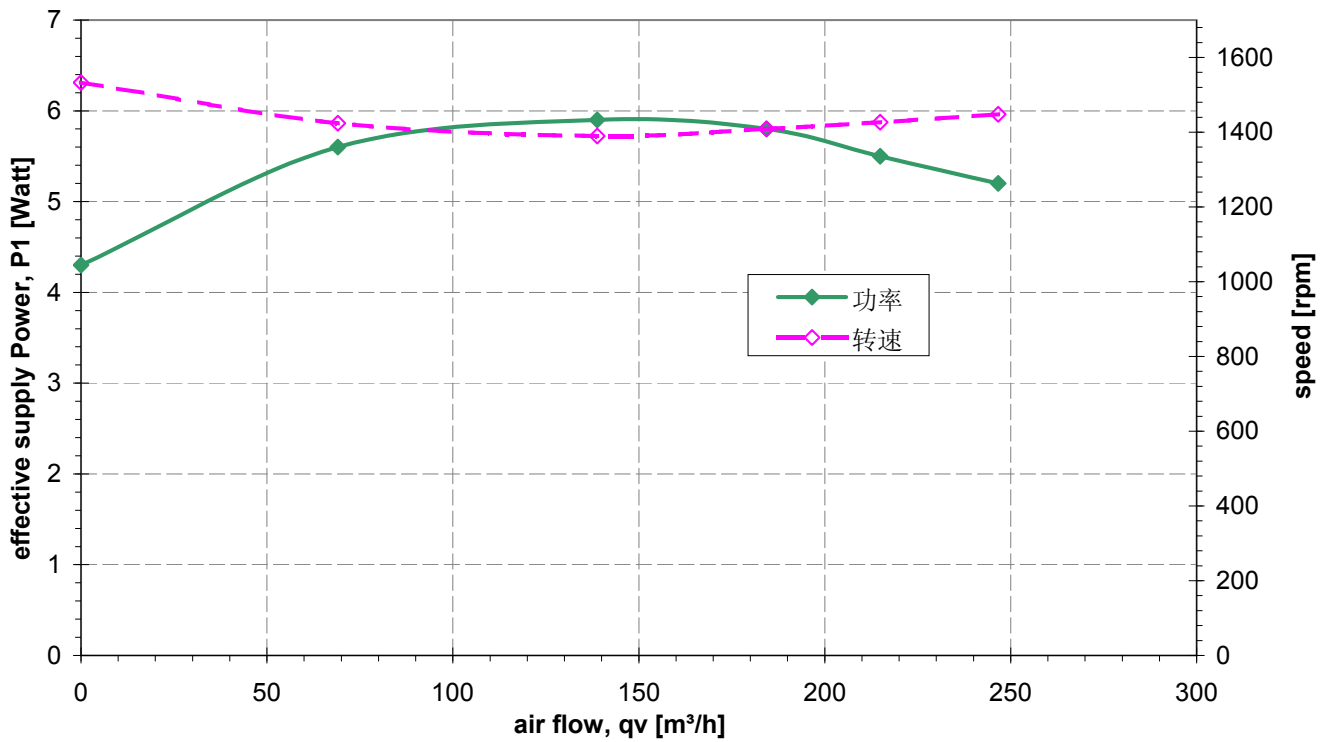
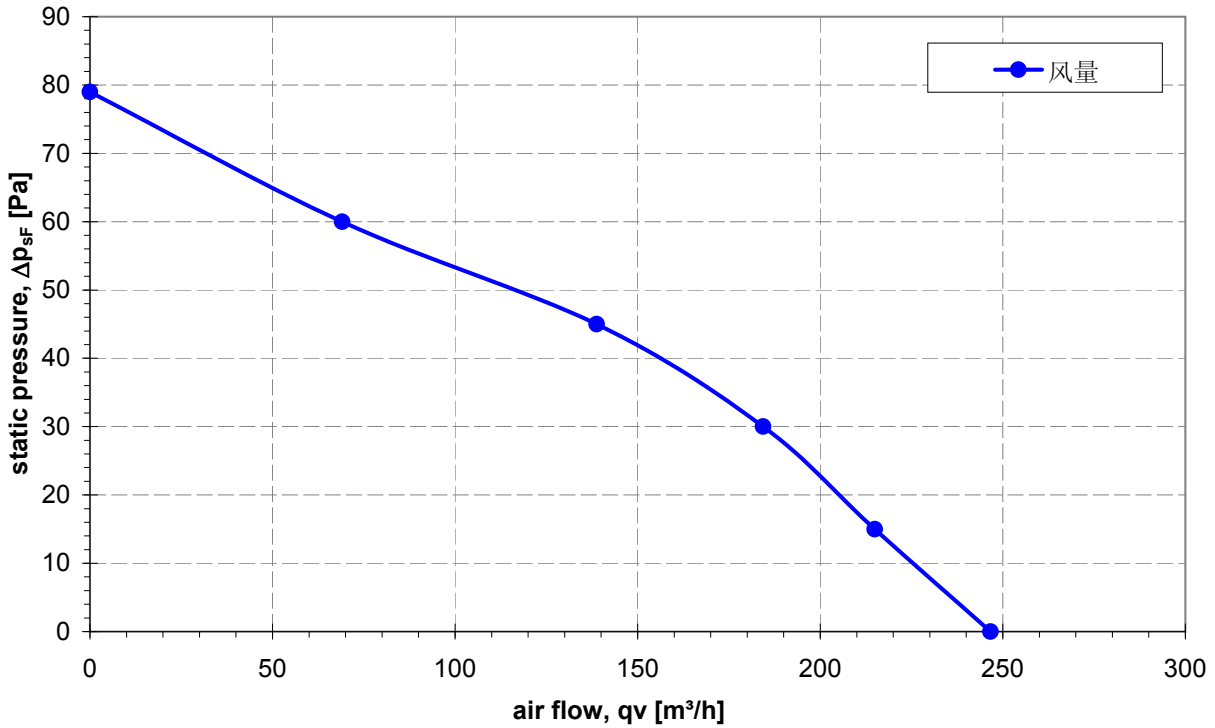

EC centrifugal fan

backward curved, single inlet

60% PWM PQ curve under 48V

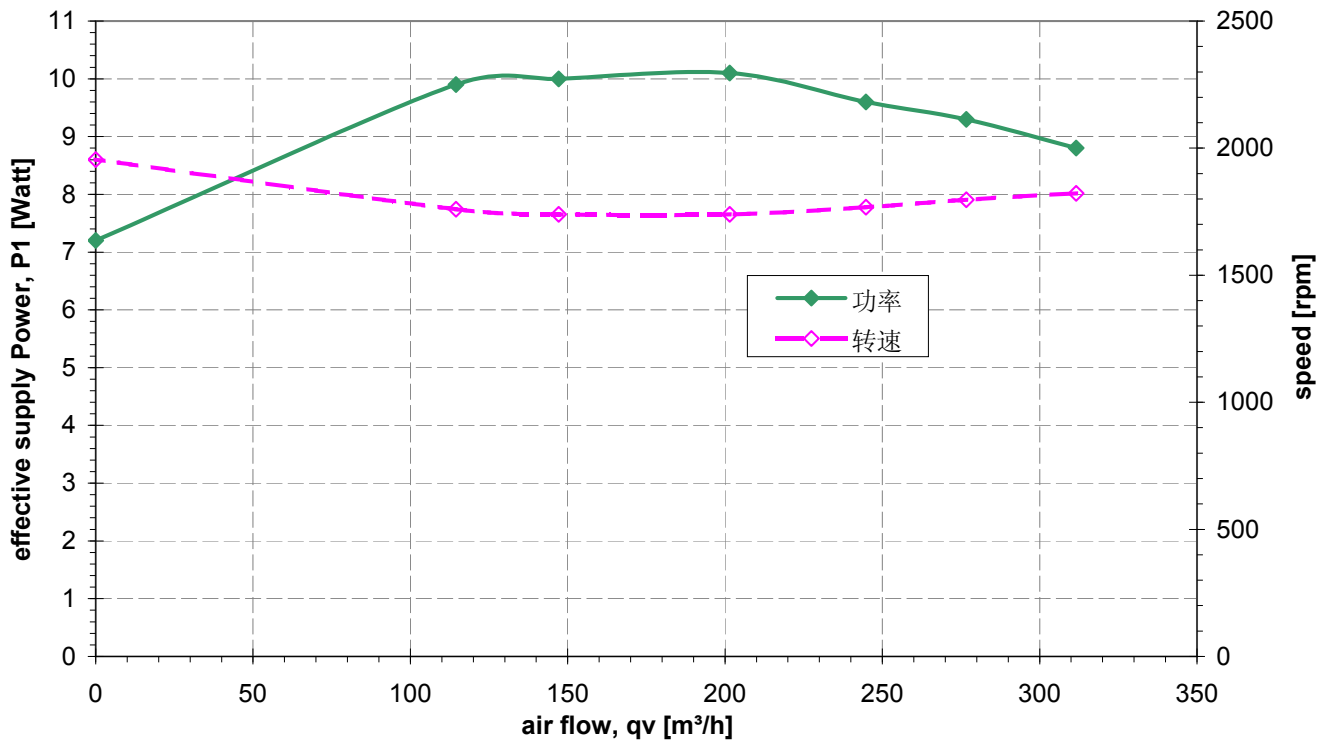
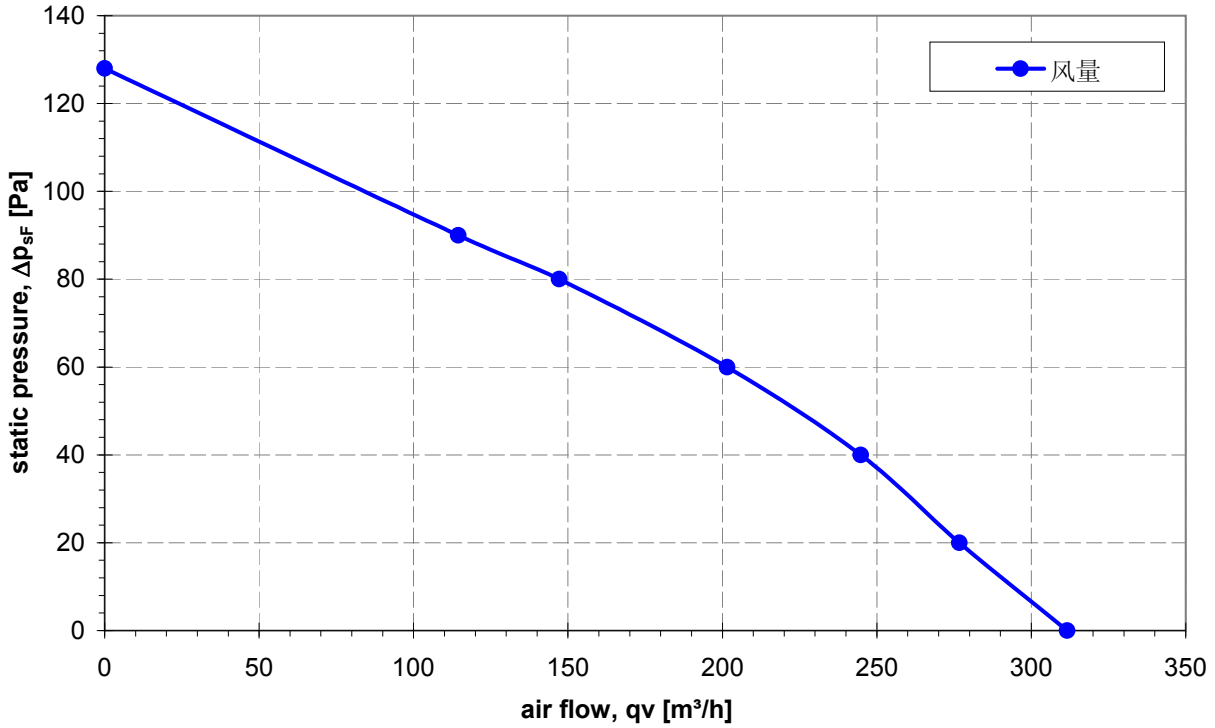

EC centrifugal fan

backward curved, single inlet

70% PWM PQ curve under 48V

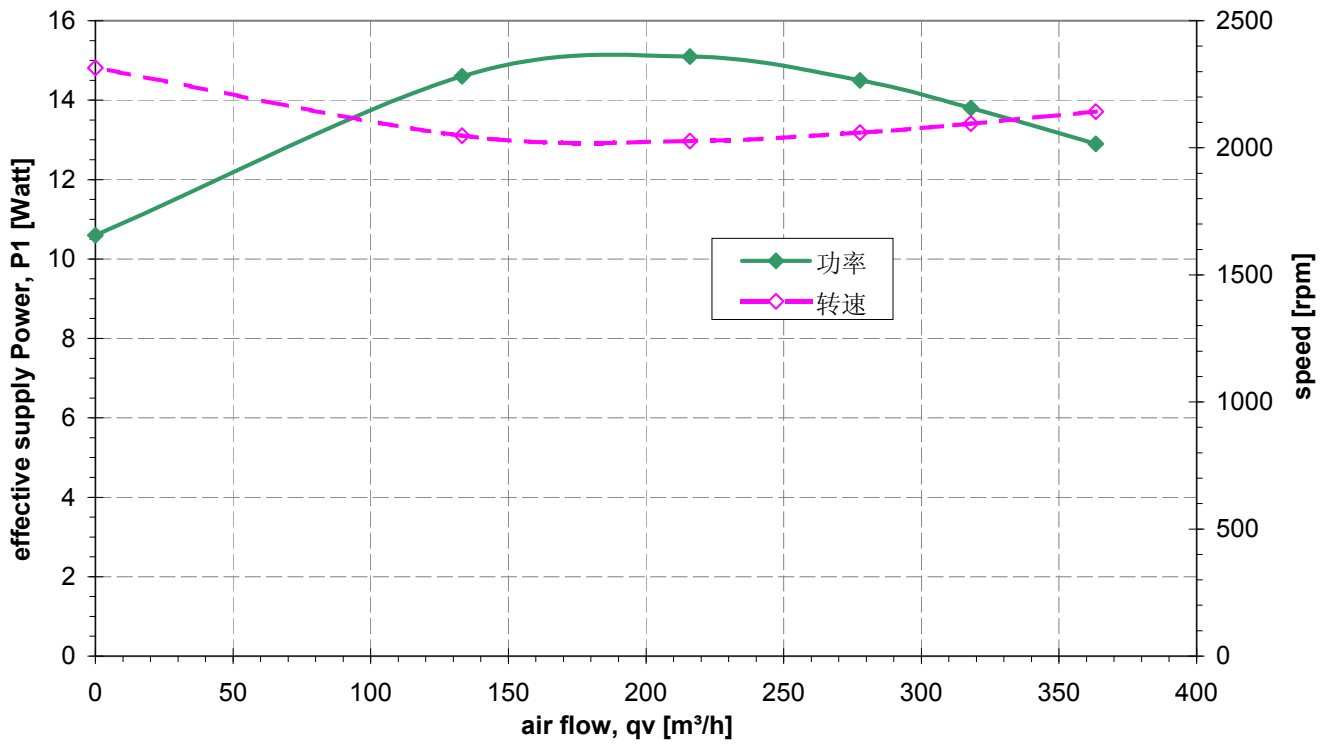
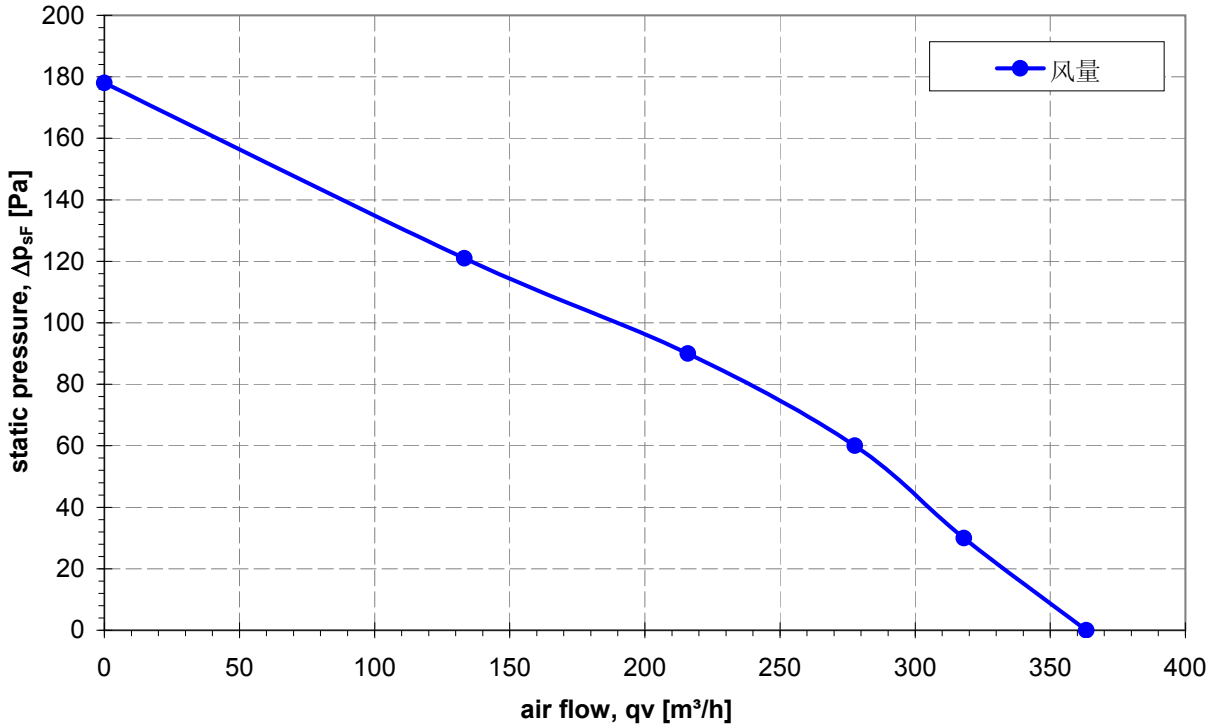

EC centrifugal fan

backward curved, single inlet

80% PWM PQ curve under 48V

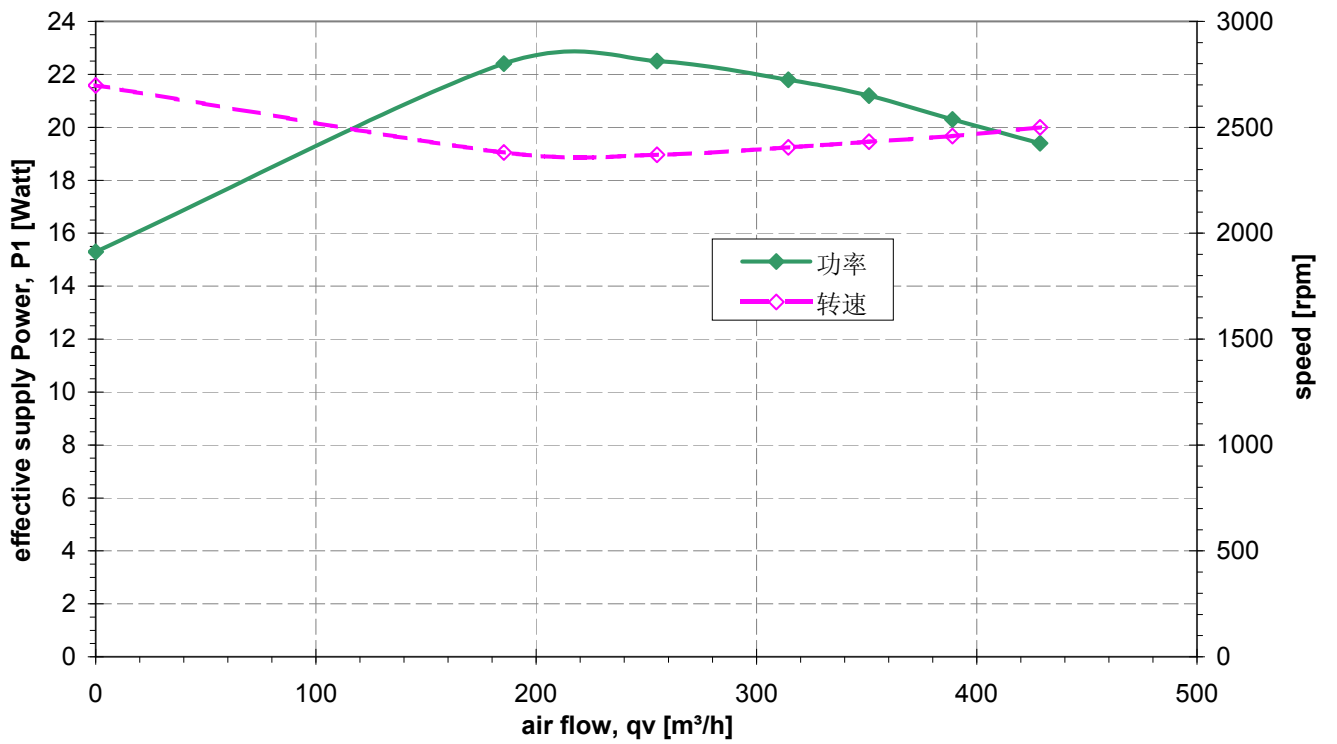
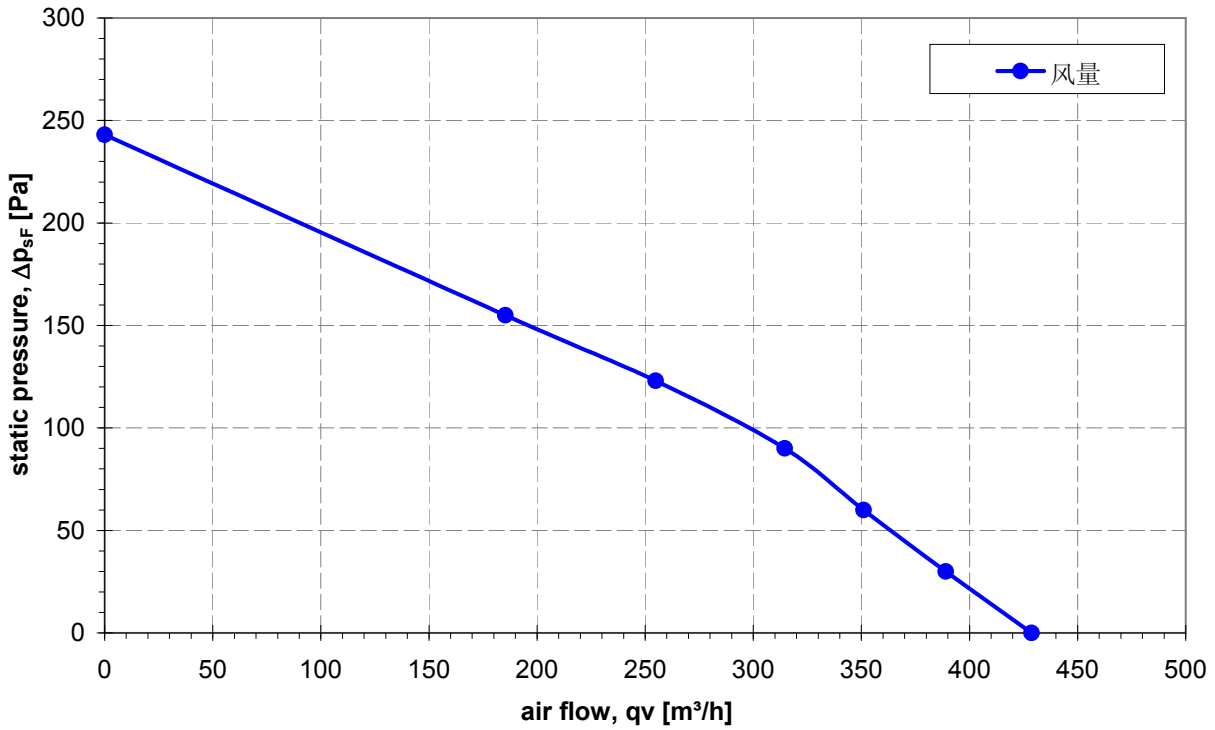

EC centrifugal fan

backward curved, single inlet

90% PWM PQ curve under 48V

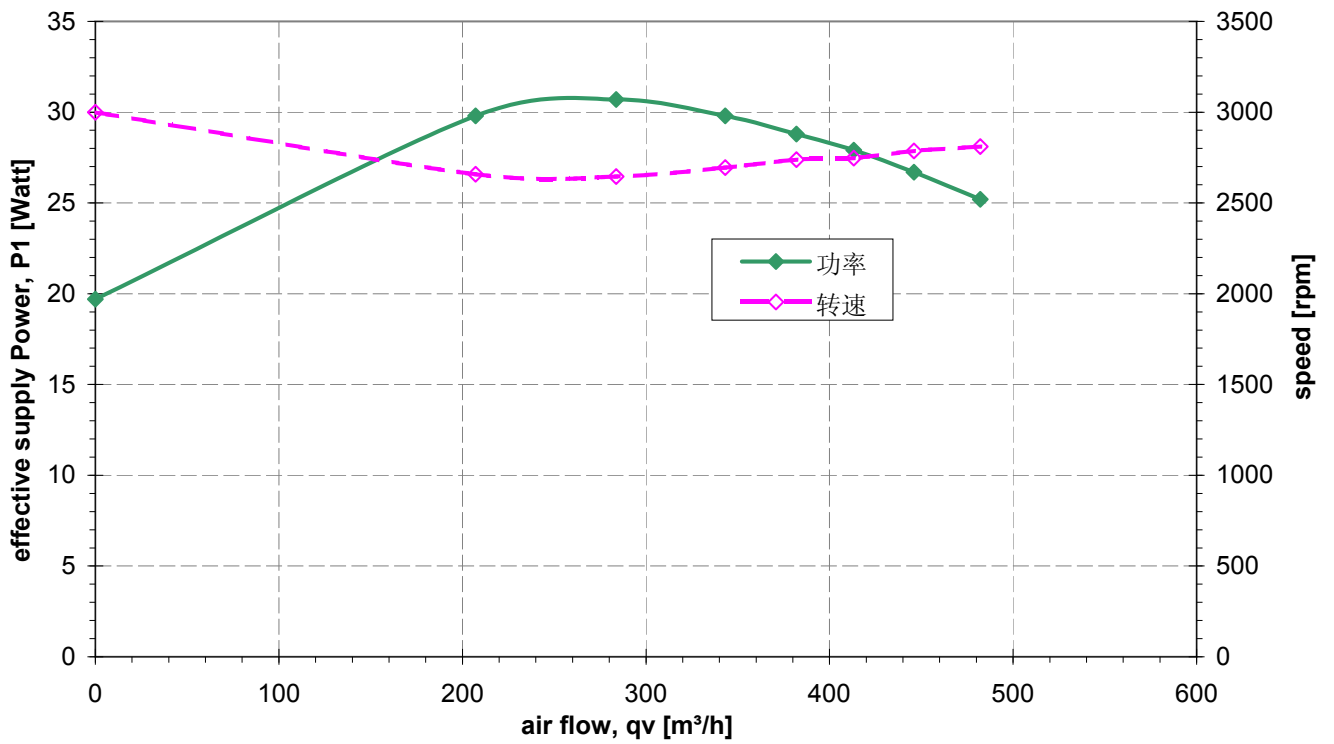
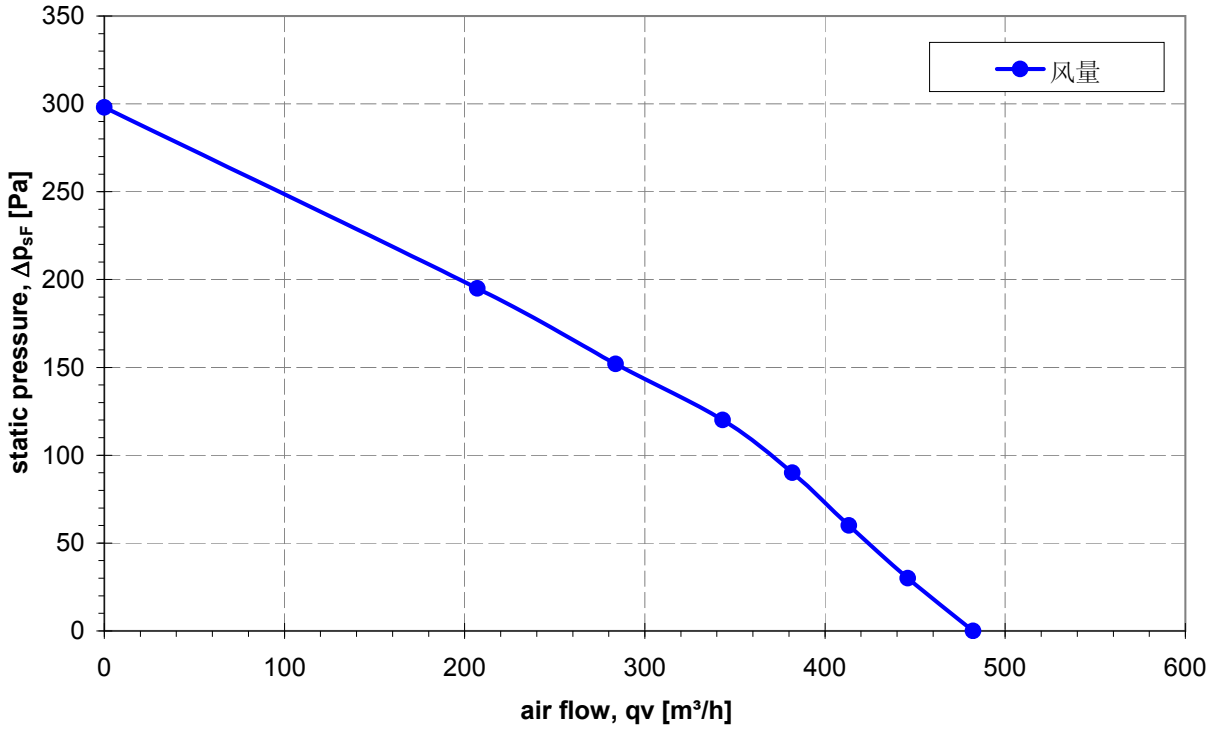

EC centrifugal fan

backward curved, single inlet

100% PWM PQ curve under 48V

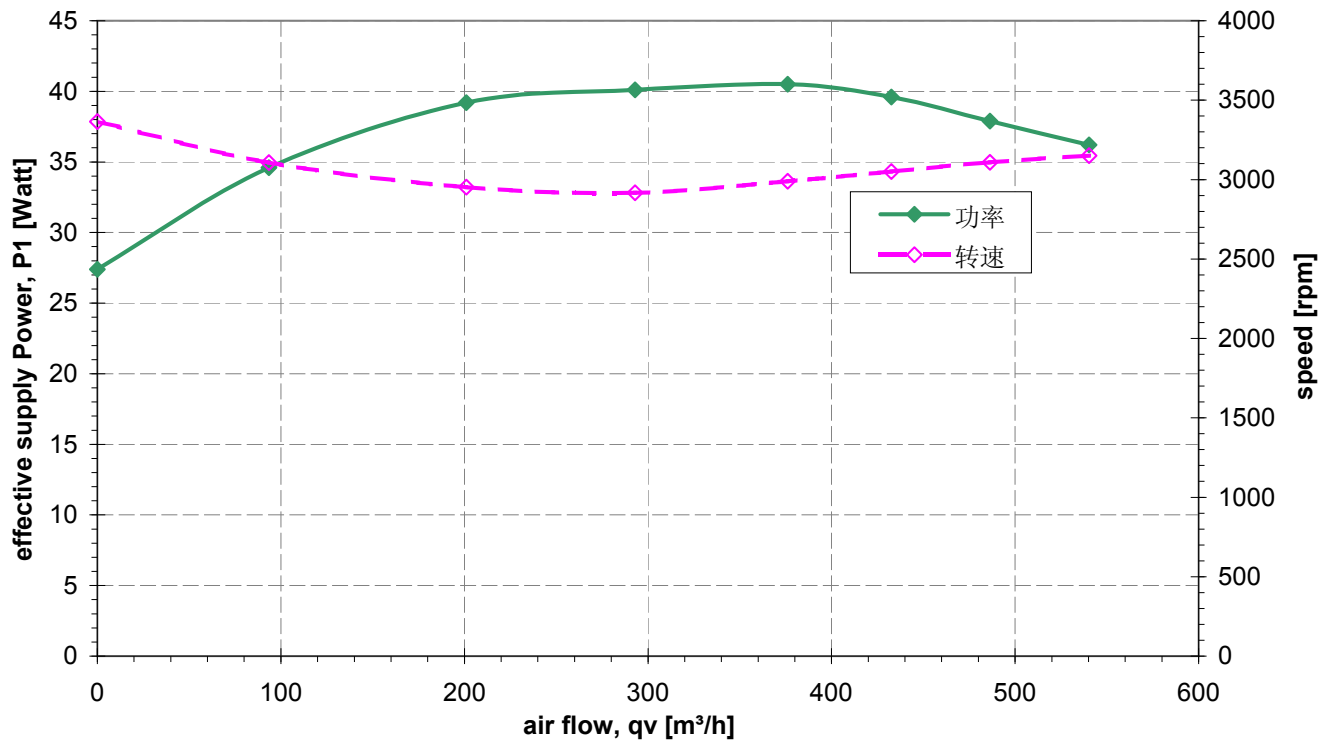
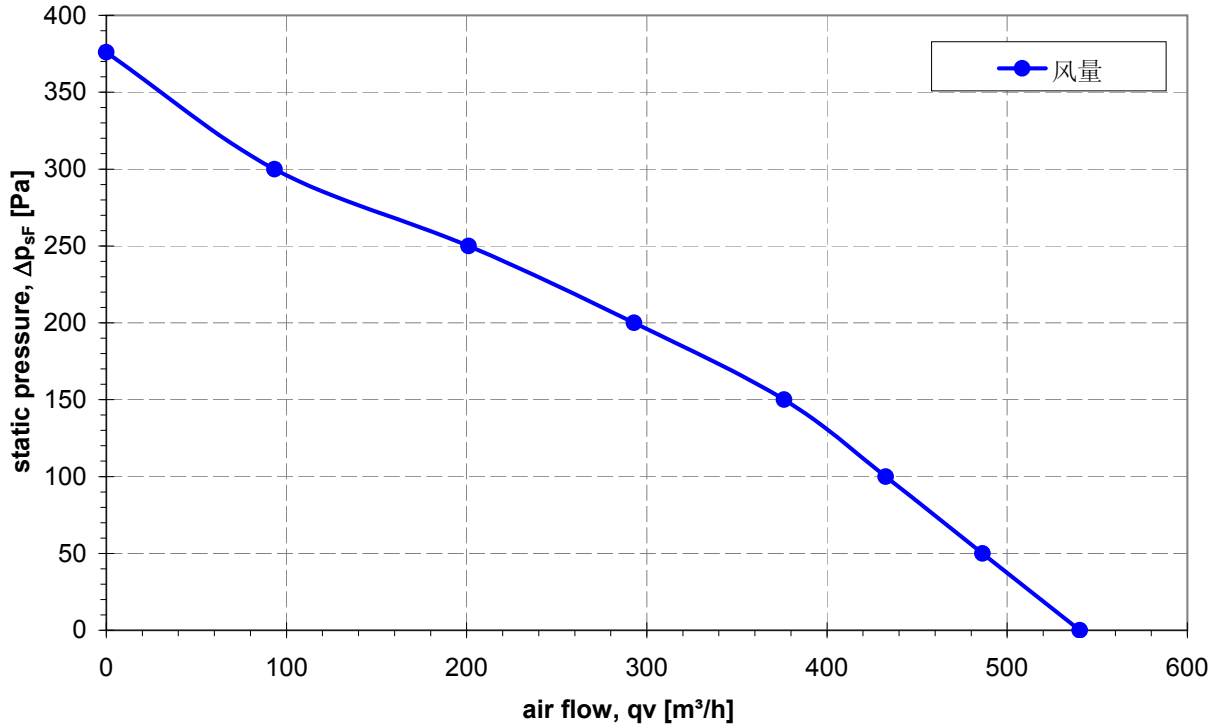

Version

Version	Date	Person	Content
A	2012-7-4	JJ	Initiat
B	2012-7-24	JJ	Add new data with Noise, amouting data